



ASTRONERGY

**TO BE THE MOST COMPETITIVE
PHOTOVOLTAIC MODULE
SUPPLIER WORLDWIDE**



www.astronergy.com



Contact us: marketing.astro@astronergy.com



Follow us @Astronergy



Follow us @ Astronergy Solar



www.youtube.com/@Astronergy

FOR A GREENER WORLD





Tier 1 PV Module Maker listed by BloombergNEF



TOP Performer honored by PVEL for 7 times



Overall Highest Achiever



Pioneer in n-type TOPCon PV Modules
Pioneer and Explorer of Smart Manufacturing in PV

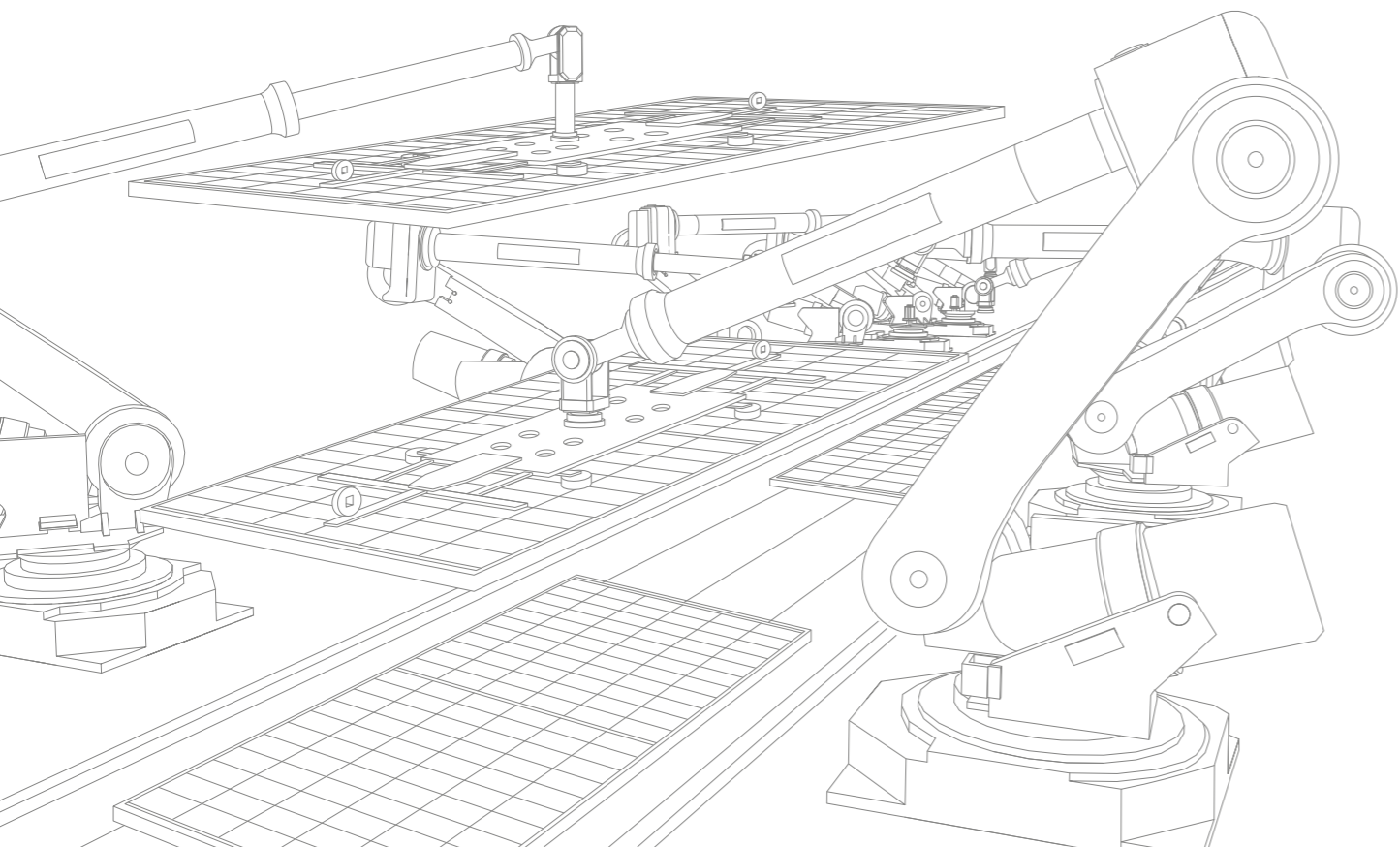

Company Profile	01-12
About CHINT Group	01
About Astronergy / Sustainability Strategy	03
Globalization / Milestones	05
Brand Value / Bankability / Intelligent Manufacturing	09
R&D Strength	11
Our Products	13-14
n-type TOPCon PV Modules	13
Applied Cases	15-20
Utility-scale Power Stations	15
Distributed PV Rooftops	19

Company Profile About CHINT Group

 **21.54 Billion USD**
2023 CHINT Group Revenue

 **50000+**
Employees Worldwide

 **140 +**
Countries and Regions Where Businesses Cover

 **3.02 Billion USD**
PV Modules Revenue in 2022

 **8.3 Million Tons**
CO2 Emissions Reduced per Year

 **8.3 Billion kWh**
Green Electricity Provided for the Whole Society per Year

Founded in 1984, CHINT Group Co., Ltd. (hereinafter referred to as "CHINT") is a global leading smart energy solutions provider. Over the past 40 years since its establishment, CHINT has always focused on industry and brand building, deeply implemented the strategy of "Industrialization, Technologization, Internationalization, Digitalization and Platformization", and formed three major segments of "Green Energy, Intelligent Electric and Smart Low-carbon" and two major platforms of "CHINT International Platform and Sci-tech Innovation Incubation Platform", and endeavored to build up "211X" Management Capabilities, including Intelligent Electric and New Energy Industry Cluster Capabilities, Regional Localization Capability, Middle and Backstage Integration Capability, and Innovation Incubation Capability. Its business covers more than 140 countries and regions, with 4 global R&D centers, 6 international marketing regions, over 25 domestic and international manufacturing bases, and a global workforce of over 50,000 employees. In 2023, CHINT's operating revenue reached USD 22.1 billion, and CHINT has been listed among the Top 500 Chinese Enterprises for more than 20 consecutive years. CHINT Electric (stock code: 601877) is the first A-share listed company in China with LV electrical appliances as its main business.

CHINT continuously strengthens its "One Cloud & Two Nets" strategy, with "CHINT Cloud" as the carrier of intelligent technology and data applications and takes the lead in building the Energy Internet of Things (EIoT) and Industrial Internet of Things (IIoT) platforms, striving to be the explorer, advocator, and practitioner in the world of low-carbon development. With the "Green Energy, Smart Network, Load Reduction, and New Storage" service systems, CHINT sets up a platform-based enterprise, and builds a regional smart energy industry ecosystem. It provides a total energy solutions package for public institutions, industrial, commercial, and end users to achieve energy conservation, carbon reduction, and accelerate the energy transition.

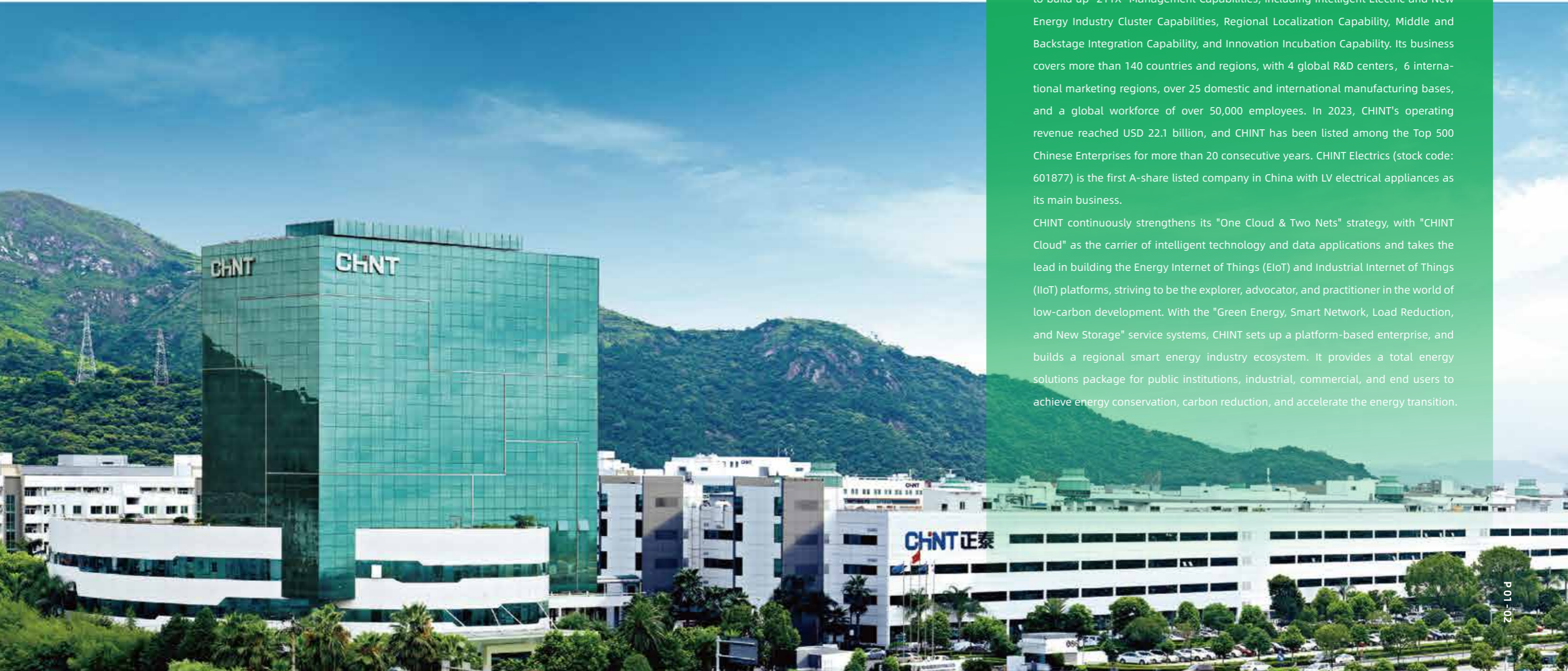



Under the CHINT Group, Astronergy is an intelligent manufacturing enterprise focusing on photovoltaic cells and modules. Founded in 2006, it is one of the earliest private enterprises in China to set foot in the photovoltaic field. And it is a pioneer in n-type TOPCon PV modules.

Committed to be the most competitive photovoltaic module supplier worldwide, Astronergy sets its mission to create a sustainable and net-zero carbon world with solar power. Focusing on R&D, production and sales of high-efficiency crystalline silicon PV cells and PV modules, Astronergy has continuously launched the ASTRO series high-efficiency, high-quality, high-performance modules. Big-size wafer tech enables both bifacial and monofacial ASTRO series modules could be perfectly applied in various scenarios such as utility-scale power stations, commercial &

industrial (C&I) PV systems and residential PV systems. Pioneered the mass production of n-type TOPCon PV modules and Astronergy keeps leads in n-type TOPCon PV cell tech.

With business footprints in over 140 countries and regions, Astronergy has established intelligent manufacturing bases at Haining in Zhejiang, Yancheng in Jiangsu, Jiuquan in Gansu, Songyuan in Jilin, Fengyang in Anhui, Yiwu in Zhejiang, Yanchi in Ningxia, Yueqing in Zhejiang and in Thailand. It has also set up branch companies and sales centers in countries like Germany, Spain, the Netherlands, Poland, the United States, Canada, Brazil, Australia, Singapore, Japan, and Thailand, achieving great sales performance of Astronergy PV products in international mainstream markets of Europe, North America, Latin America, and Asia Pacific.



80 GW+
Total Global Shipments



76 GW
2024 Estimated PV Modules Capacity



65 GW
2024 Estimated PV Cells Capacity



103 GW+
2025 Estimated PV Modules Capacity



88 GW+
2025 Estimated PV Cells Capacity

ZERO BY 2050 Carbon Neutrality



Globalization

Astronergy product sales footprint covers more than 140 countries around the world. And it has set up branches in the United States, Germany, Australia, Canada, Singapore, Thailand, Japan and other countries to help the process of globalization and win the full trust of customers and good reputation in the industry with credibility.

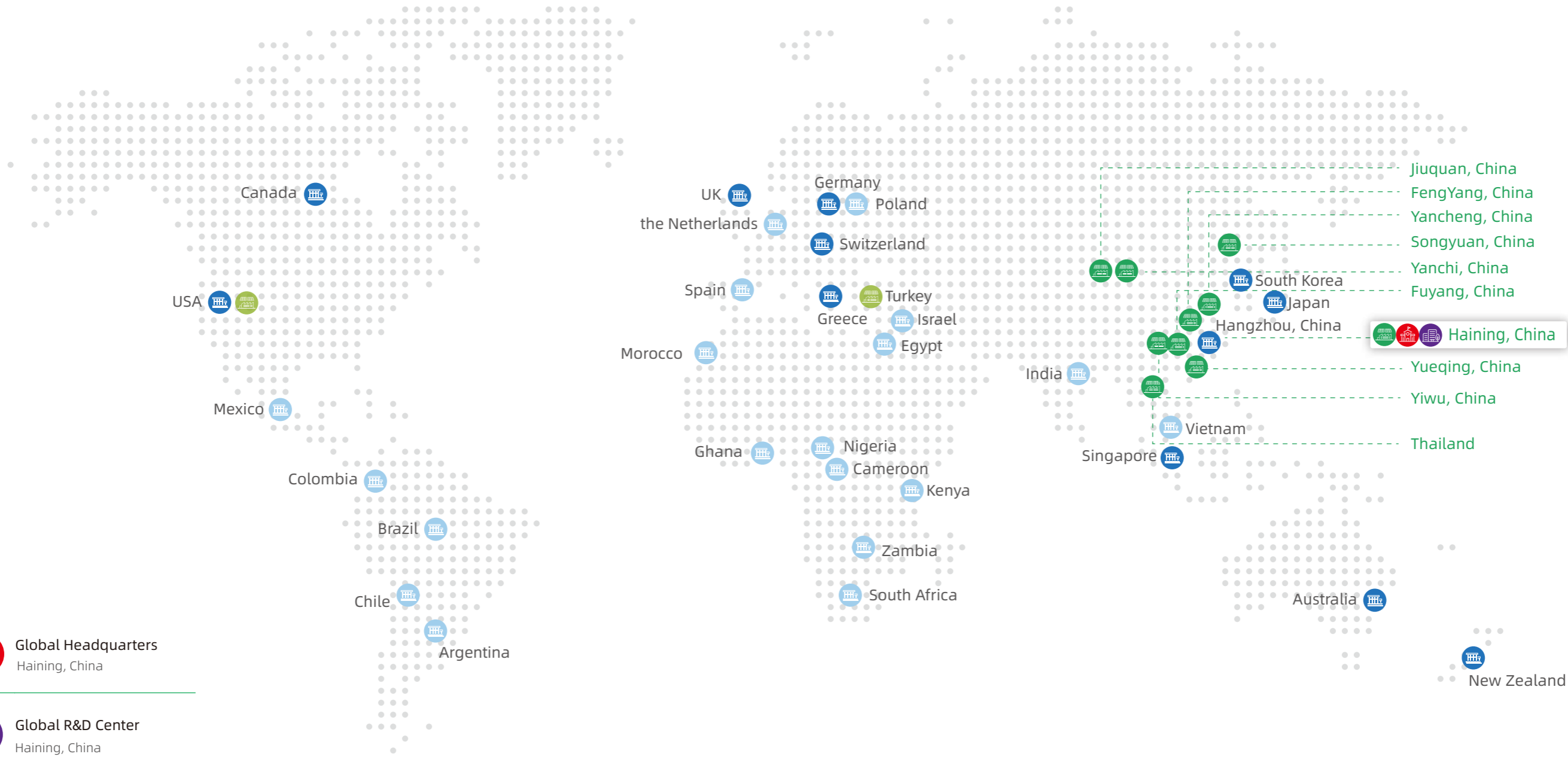

Global Headquarters
Haining, China

Global R&D Center
Haining, China

Global Sales Offices

Hangzhou, China	Canada
USA	Singapore
Germany	Thailand
Australia	Japan
South Korea	...

Global Manufacturing Bases (Mass Production)

Haining, China	Yiwu, China
Yancheng, China	Yanchi, China
Jiuquan, China	Fuyang, China
Songyuan, China	Yueqing, China
Fengyang, China	Thailand

Global Sales Channels

Spain	Morocco
the Netherlands	Chile
Brazil	Israel
India	Argentina
Poland	Vietnam
Egypt	Mexico
Colombia	...







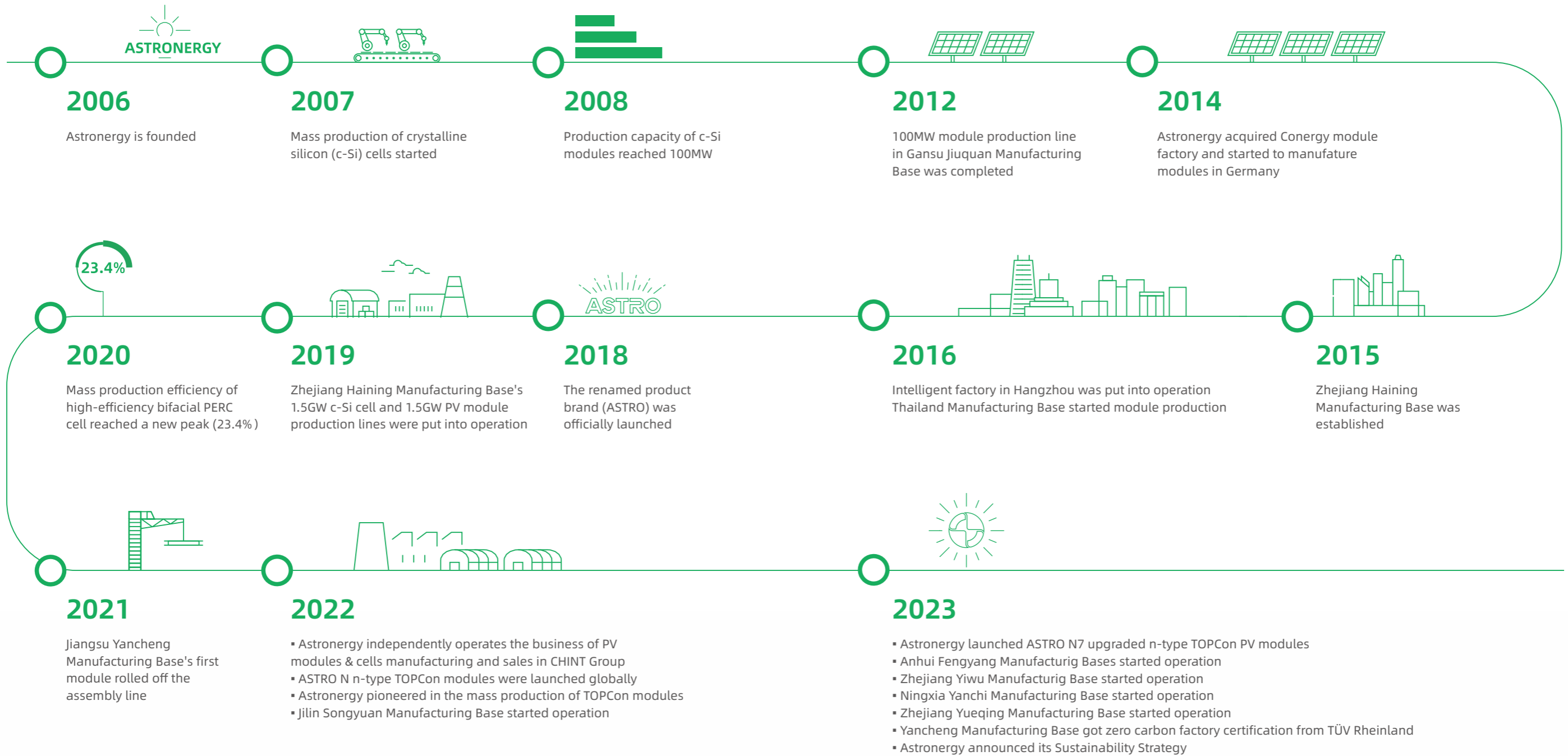

Global Manufacturing Bases (under construction)

USA
Turkey
...

Milestones



Brand Value

 <p>For 7 years, Astronergy has been honored by PVEL as "TOP Performer" among module manufacturers</p>	 <p>Astronergy has won 8 awards of "All Quality Matters" from TÜV Rheinland</p>	<p>Tier 1 BloombergNEF</p> <p>For a long time, Astronergy has been listed as the world's Tier 1 PV Module Maker by Bloomberg NEF</p>
 <p>TOP 10 PV Modules Suppliers released by S&P Global</p>	 <p>No. 1 in "China's Top 100 Private Enterprises with Social Responsibility" in 2022</p>	 <p>No. 82 in "2022 China's Top 500 Private Enterprises"</p>
 <p>No. 235 in "2021 Top 500 Chinese Enterprises"</p>	 <p>China Industry Award</p>	 <p>China Charity Award</p>

Bankability

In the annual "PV Module and Inverter Bankability" released by Bloomberg New Energy Finance (BNEF), Astronergy bankability rating has risen from seventh place on the 2022 list to sixth place on the 2023 list. And Astronergy has been in the upper for multiple consecutive quarters in PV ModuleTech bankability ratings report for 2023 and is rated as "A" in Q1 2024.

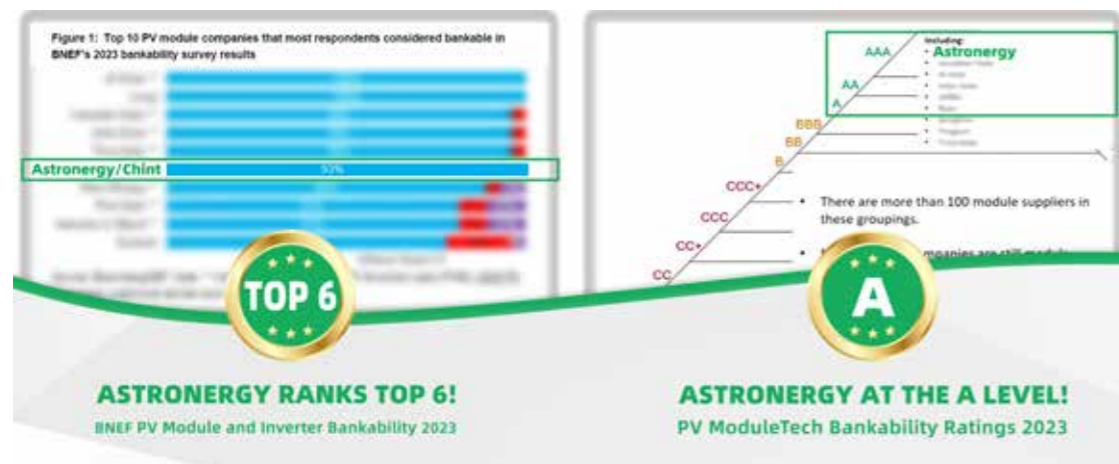

Intelligent Manufacturing

 **Pioneer and Explorer of Smart Manufacturing in PV Industry**
Astronergy builds the first PV "Intelligent Manufacturing" transparent factory

With the automatic production line and highly information-integrated production mode, Astronergy enables the monitoring and traceability in the production process from raw materials to finished products and maintains its leading position in smart manufacturing.

 **1st to Achieve AI Automatic Detection of EL Defects**

- * Supported by Big Data
- * Localization of Production Equipment
- * Fully Automated Production
- * AI Quality Detection
- * Automatic Monitoring of the Entire Process
- * Automatic Batching by Unmanned Vehicles

 **Outstanding in Intelligent Manufacturing**

- * Sino-German Intelligent Manufacturing Demonstration Base
- * Intelligent Photovoltaic Pilot Demonstration Enterprise





R&D Strength

Global R&D Cooperation

Explore the "industry university research" integration mode with Shanghai Jiao Tong University, Zhejiang University, Zhejiang University of Technology, Hangzhou University of Electronic Science and Technology, New South Wales, Chinese Academy of Sciences Ningbo Institute of Materials and other universities and research institutions, integrate global innovation resources, and promote enterprise R&D innovation and talent training. Deeply cooperate with domestic and foreign frontline equipment and material manufacturers, carry out collaborative innovation in the industrial chain, and promote industry material innovation and industrialization.



Zhejiang University
Key Technologies of Low-cost and High-efficiency Solar Cells



Shanghai Jiao Tong University
New Tunnel Passivated High-efficiency Solar Cell & Module Technology



Zhejiang University of Technology
N-type Passivated Contact High-efficiency Bifacial Crystalline Silicon Solar Cells



Hangzhou Dianzi University
High-efficiency Monocrystalline PERC Cell Technology



UNSW SYDNEY
Hydrogen Passivation Project

Accreditation Laboratory Qualifications

With strong testing capabilities, Astronergy has obtained the qualifications of CNAS Laboratory, CSA Witness Laboratory, TÜV Rheinland Witness Laboratory, Intertek "Satellite Program" Laboratory and other qualifications, and conducts more than 30 rigorous tests internally for PV modules.

Scientific Research Achievements

273 Utility Model Patents

77 Invention Patents

11 Appearance Design Patents

Leading in Cell & Module Efficiency



The average efficiency of mass-production n-type TOPCon 4.0 cells reaches **26.3%**
The average efficiency of pilot line-production n-type TOPCon 4.0 cells achieves **26.6%**,
and the highest efficiency hits **26.9%**

Scientific Projects



The number of R&D personnel with intermediate titles and above at the national level accounts for more than **20%+**



Launched 2 Provincial-Level Frontier Innovation Projects (From 2023 to 2024)

Talent Declaration



Zhejiang Core Energy's Key Cooperative R&D Projects



Jiaxing Leading Team on Innovation



Haining Demonstration Project on Collaborative Innovation

Our Products — n-type TOPCon Ultra-High Power Modules

Astronergy is a pioneer in n-type TOPCon PV modules.

ASTRO N series adopts n-type TOPCon PV cell technology, featured advanced technologies such as multi-busbar (MBB) half-cut wafer (N7 adopts the latest SMBB half-cut wafer), non-destructive cutting, high-density encapsulation, etc., to achieve advantages such as high power, high efficiency, high reliability, high power generation per watt, low BOS and low LCOE, and can meet the needs of multiple scenarios such as utility-scale power plants, commercial and industrial distributed power plants, and residential power plants.

- 15** Years Product Warranty Period
- 30** Years Power Warranty Period
- ≤1.0%** First-year Power Degradation
- ≤0.4%** Annual Power Degradation

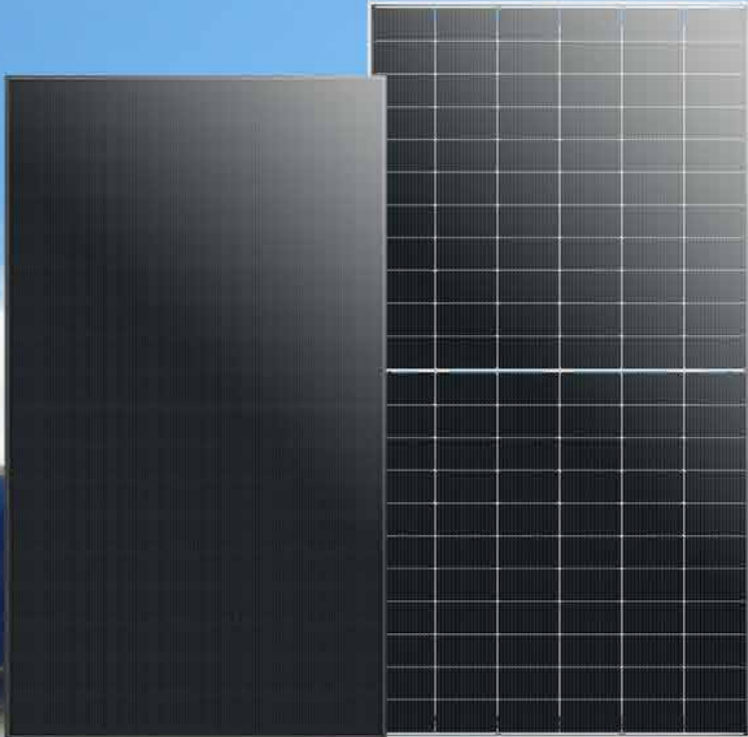

ASTRO N7
 625W / TOPCon 4.0 / Rectangular Wafer
 SMBB Tech / Light Redirecting Film For Dual-glass Products



Application Scenarios:
 Utility-scale Power Stations and Distributed Power Stations



ASTRO N5
 600W / 183R Wafer

Application Scenarios:
 Utility-scale Power Stations and Distributed Power Stations

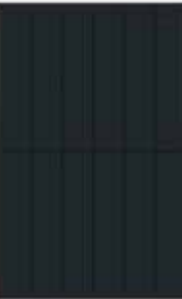

ASTRO N7s
 460W / TOPCon 4.0 / Rectangular Wafer
 ZBB-TF Tech

Application Scenarios:
 Residential Rooftop Solar Power Systems and C&I Distributed Solar Power Systems

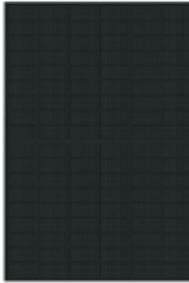

ASTRO N5s
 445W / 183R Wafer

Application Scenarios:
 Residential Photovoltaic Rooftops





1050MW ☰ Panjiang Utility-scale Solar Plant
📍 Guanling county, Guizhou province, China



50MW ☰ Barreiras Project
📍 Brazil



15MW ☰ Utility-scale Solar Plant
📍 Gelderland, Netherlands



70MW ☰ Utility-scale Project in Zhangjiakou
📍 Zhangjiakou, Hebei Province, China



132MW ☰ Claresholm Solar Farm
📍 Southern Alberta, Canada



200MW ☰ Forest-Solar Hybrid Power Station
📍 Jiangshan, Quzhou, Zhejiang Province, China



89MW ☰ Goonumbla Project
📍 Australia



310MW ☰ China's First Sand-Solar Hybrid Power Station
📍 Kubuqi, Inner Mongolia, China



550MW ☰ The Largest Fishing-Solar Hybrid Project in Asia
📍 Wenzhou, Zhejiang Province, China



165MW ☰ Benban Solar Park Project
📍 Egypt



48.5MW ☰ Insua Power Station
📍 Portugal

Applied Cases Utility-scale PV Power Stations



154.4MW Germany Döllen Solar Farm
Brandenburg, Germany



3MW Depot Park-Sacramento, CA
USA



1000MW China Tacheng Multi-energy Complementary Project
Tacheng, Xinjiang, China



70MW Italy Rovigo Solar Park
Italy



119MW Australia Hillston Solar Park
New South Wales, Australia



200MW China Jiangshan Agriculture-PV Complementary Project
Quzhou, Zhejiang, China



18MW Japan Nagano Solar Park
Japan



1000MW China Kela Hydro-solar Complementary Power Plant
West Sichuan Plateau, China



310MW China Kubuqi Sand-Solar Hybrid Project
Kubuqi, Inner Mongolia, China



81MW Brazil SOL DO FUTURO Solar Park
Aquiraz, Ceará, Brazil



79MW Dominica Soco Solar Park
Dominican Republic

Applied Cases **Distributed Rooftop PV Power Stations**



10MW ☰ Roof Photovoltaic Power Station of Hangzhou East Railway Station
📍 Hangzhou, Zhejiang Province, China

* **4.2MW**
Rooftop Project of Hangzhou South Railway Station
Hangzhou, Zhejiang Province, China

* **4MW**
Project "Million Rooftops for Zhixi"
Quzhou, Zhejiang Province, China

* **23MW**
C&U Group Rooftop Project
Wenzhou, Zhejiang Province, China

...



15MW ☰ D&Y Textile distributed rooftop solar generation plant
📍 Malaysia



1.2MW ☰ Hangzhou Civic Center Podium Roof Photovoltaic Power Station
📍 Hangzhou, Zhejiang Province, China



10.3MW ☰ Geely Automobile PV Rooftop Project in Linhai
📍 Linhai, Zhejiang Province, China



10MW ☰ Hikvision Rooftop Project
📍 Hangzhou, Zhejiang Province, China



30MW ☰ Jintian Copper BIPV Power Station
📍 Ningbo, Zhejiang Province, China

